

Directions for mounting APF/APFE, STAIR2/STAIRE2 and Handrails to ProFlex Platform

1. Start assembly by sliding in the 2 assembly inserts into the side of the stage where you will be attaching the stairs. **Figure A**

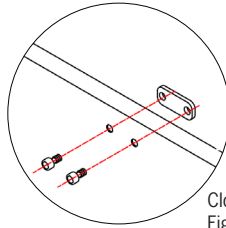
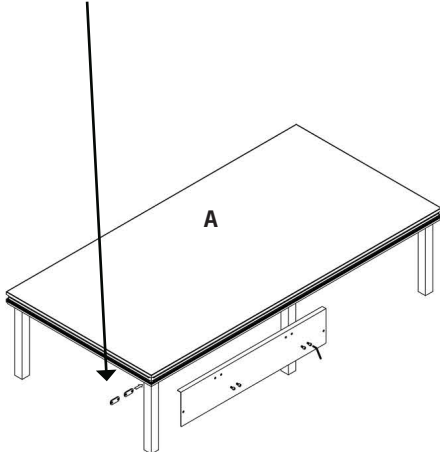

Close-up View of Figure B

2. Attach the connecting panel to the assembly inserts on the side of the stage platform with provided screws and hex key. **Figure B**

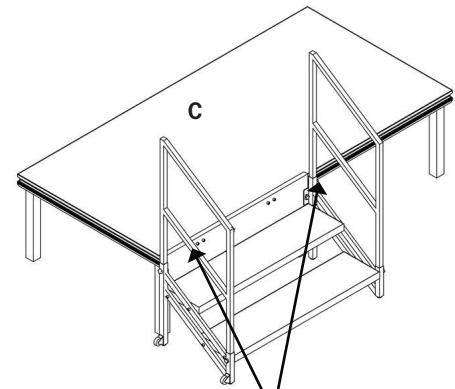
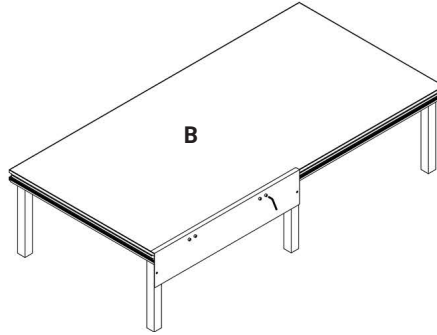

3. Attach the stairs to the connecting panel with the provided screws and hex key. **Figure C**

